

DATE : 03/10/2021

Time : 3 hrs.

Answers & Solutions for JEE (Advanced)-2021

Max. Marks: 180

PAPER - 1

PART-I : PHYSICS

SECTION - 1

- This section contains **FOUR (04)** questions.
- Each question has **FOUR** options (A), (B), (C) and (D). **ONLY ONE** of these four options is the correct answer.
- For each question, choose the option corresponding to the correct answer.
- Answer to each question will be evaluated according to the following marking scheme:

Full Marks : +3 If **ONLY** the correct option is chosen;

Zero Marks : 0 If none of the options is chosen (i.e. the question is unanswered);

Negative Marks : -1 In all other cases.

1. The smallest division on the main scale of a Vernier calipers is 0.1 cm. Ten divisions of the Vernier scale correspond to nine divisions of the main scale. The figure below on the left shows the reading of this calipers with no gap between its two jaws. The figure on the right shows the reading with a solid sphere held between the jaws. The correct diameter of the sphere is

- (A) 3.07 cm
- (B) 3.11 cm
- (C) 3.15 cm
- (D) 3.17 cm

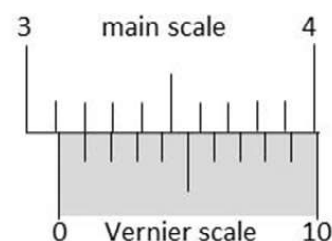
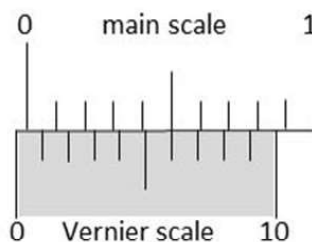

Answer (C)



Sol. Least count of Vernier calipers = 0.01 cm

$$\begin{aligned}\text{Error in scale} &= 4 \text{ LC} \\ &= 0.04 \text{ cm}\end{aligned}$$

$$\begin{aligned}\text{Reading} &= 3.1 \text{ cm} + 1 \text{ L.C} \\ &= 3.1 \text{ cm} + 0.01 \\ &= 3.11 \text{ cm}\end{aligned}$$

$$\begin{aligned}\text{So correct diameter of the sphere} & \\ &= (3.11 + 0.04) \text{ cm} \\ &= 3.15 \text{ cm}\end{aligned}$$

So, option (C)

2. An ideal gas undergoes a four step cycle as shown in the $P - V$ diagram below. During this cycle, heat is absorbed by the gas in

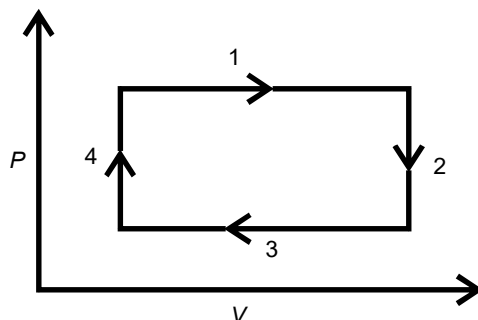

- (A) steps 1 and 2
(B) steps 1 and 3
(C) steps 1 and 4
(D) steps 2 and 4

Answer (C)

Sol. Given $P - V$ diagram

For process (1)

$$\Delta Q_1 = nC_p \Delta T$$

As $P = \text{constant}$ and V increases

so T will increase

$$\text{So } \Delta Q_1 > 0$$

For process (2)

$$\Delta Q_2 = nC_v \Delta T$$

$V = \text{constant}$, $P \downarrow$, So $T \downarrow$

For process (3), $\Delta Q_3 = nC_p \Delta T < 0$

For process (4), $\Delta Q_4 = nC_p \Delta T$

As $\Delta T > 0$

So $\Delta Q_4 > 0$

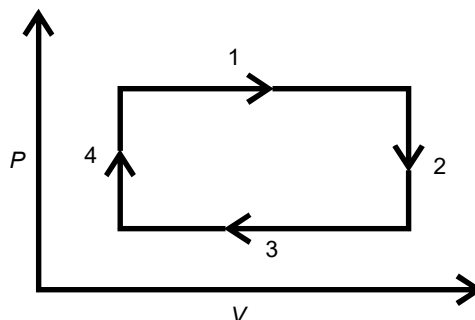

3. An extended object is placed at point O, 10 cm in front of a convex lens L_1 and a concave lens L_2 is placed 10 cm behind it, as shown in the figure. The radii of curvature of all the curved surfaces in both the lenses are 20 cm. The refractive index of both the lenses is 1.5. The total magnification of this lens system is

- (A) 0.4
(B) 0.8
(C) 1.3
(D) 1.6

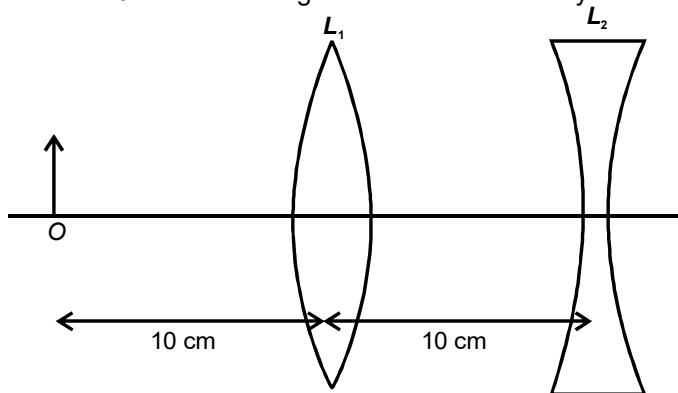

Answer (B)

Sol. $\frac{1}{v_1} - \frac{1}{-10} = \frac{1}{20}$

$$\Rightarrow \frac{1}{v_1} = \frac{1}{20} - \frac{1}{10} = \frac{-1}{20}$$

$$\Rightarrow v_1 = -20 \text{ cm}$$

$$m_1 = \frac{v}{u} = \frac{-20}{-10} = 2$$

again $\frac{1}{v_2} - \frac{1}{-30} = \frac{1}{-20}$

$$\Rightarrow \frac{1}{v_2} = -\frac{1}{30} - \frac{1}{20} = -\frac{5}{60} = -\frac{1}{12}$$

$$m_2 = -\frac{12}{-30} = \frac{2}{5}$$

$$m = m_1 \times m_2 = 2 \times \frac{2}{5} = 0.8$$

$$\frac{1}{f_1} = \left(\frac{3}{2} - 1\right) \left(\frac{2}{20}\right)$$

$$= \frac{1}{20}$$

4. A heavy nucleus Q of half-life 20 minutes undergoes alpha-decay with probability of 60% and beta-decay with probability of 40%. Initially, the number of Q nuclei is 1000. The number of alpha-decays of Q in the first one hour is

- (A) 50
(B) 75
(C) 350
(D) 525

Answer (D)



Sol: $t_{1/2} = 20$ min

In 60 min, no. of half-life = 3

$$\Rightarrow N_A = \left[1000 - \frac{1000}{2^3} \right] \times 0.6$$

$$= 1000 \times \frac{7}{8} \times 0.6$$

$$= 525$$

SECTION - 2

- This section contains **THREE (03)** question stems.
- There are **TWO (02)** questions corresponding to each question stem.
- The answer to each question is a **NUMERICAL VALUE**.
- For each question, enter the correct numerical value corresponding to the answer in the designated place using the mouse and the on-screen virtual numeric keypad.
- If the numerical value has more than two decimal places, **truncate/round-off** the value to **TWO** decimal places.
- Answer to each question will be evaluated according to the following marking scheme:

Full Marks : +2 If ONLY the correct numerical value is entered at the designated place;

Zero Marks : 0 In all other cases.

Question Stem for Question Nos. 5 and 6

Question Stem

A projectile is thrown from a point O on the ground at an angle 45° from the vertical and with a speed $5\sqrt{2}$ m/s. The projectile at the highest point of its trajectory splits into two equal parts. One part falls vertically down to the ground, 0.5 s after the splitting. The other part, t seconds after the splitting, falls to the ground at a distance x meters from the point O . The acceleration due to gravity $g = 10$ m/s².

5. The value of t is _____.

Answer (00.50)

Sol. $H = \frac{u^2 \sin^2 \theta}{2g}$

$$= \frac{50}{2 \times 10} \times \frac{1}{2} = \frac{5}{4}$$

$$t = \sqrt{\frac{2H}{g}} = \sqrt{\frac{2 \times 5}{4 \times 10}}$$

$$t = \frac{1}{2} \text{ s} = 0.5 \text{ sec}$$

Ans. 00.50



6. The value of x is _____.

Answer (07.50)

Sol. $X = \frac{3R}{2}$ as $X_{\text{cm}} = R$

$$R = \frac{u^2 \sin^2 \theta}{g} = \frac{50}{10} = 5$$

$$\Rightarrow X = \frac{3R}{2} = \frac{15}{2} = 7.5 \text{ m}$$

Ans.: 07.50

Question Stem for Question Nos. 7 and 8

Question Stem

In the circuit shown below, the switch S is connected to position P for a long time so that the charge on the capacitor becomes $q_1 \mu\text{C}$. Then S is switched to position Q . After a long time, the charge on the capacitor is $q_2 \mu\text{C}$.

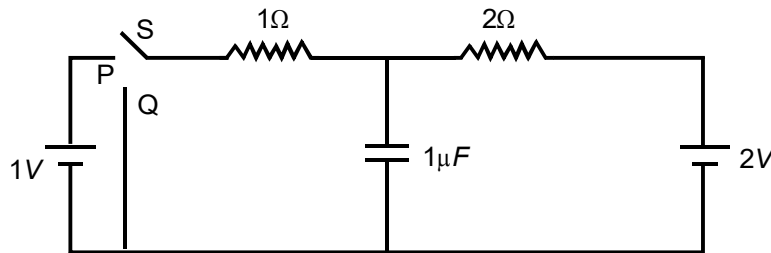

7. The magnitude of q_1 is _____.

Answer (01.33)

Sol. With switch S at position P after long time potential difference across capacitor branch

$$= \frac{\frac{2}{2} + \frac{1}{1}}{\frac{1}{2} + \frac{1}{1}} = \frac{2 \times 2}{3} = \frac{4}{3} \text{ V}$$

$$\Rightarrow \text{Charge on capacitor } q_1 \mu\text{C} = \frac{4}{3} \mu\text{C}$$

$$\Rightarrow q_1 = \frac{4}{3} = 1.33$$

8. The magnitude of q_2 is _____.

Answer (00.67)

Sol. With switch S at position Q after long time potential difference across capacitor

= potential difference across resistance of 1 ohm.

$$= \frac{2}{3} \text{ V}$$

$$\Rightarrow \text{charge on capacitor } q_2 \mu\text{C} = \frac{2}{3} \mu\text{C}$$

$$\Rightarrow q_2 = 0.67$$

Question Stem for Question Nos. 9 and 10

Question Stem

Two point charges $-Q$ and $+Q/\sqrt{3}$ are placed in the xy -plane at the origin $(0, 0)$ and a point $(2, 0)$, respectively, as shown in the figure. This results in an equipotential circle of radius R and potential $V = 0$ in the xy -plane with its center at $(b, 0)$. All lengths are measured in meters.

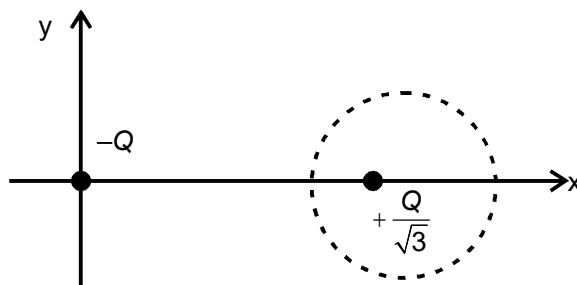

9. The value of R is ___ meter

Answer ($R = 01.73$)

10. The value of b is ___ meter

Answer ($b = 03.00$)

Solution for Q. Nos. 9 & 10

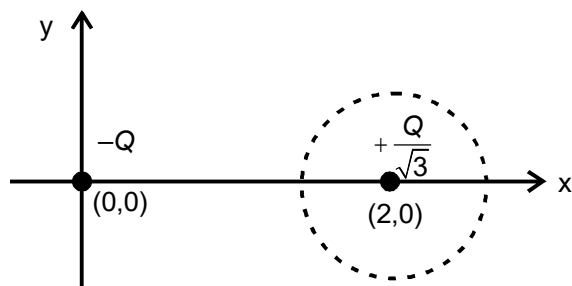

$$V(x,y) = \frac{1}{4\pi\epsilon_0} \left(-\frac{Q}{\sqrt{x^2 + y^2}} + \frac{Q}{\sqrt{3}\sqrt{(x-2)^2 + y^2}} \right)$$

$$\Rightarrow 3(x-2)^2 + 3y^2 = x^2 + y^2$$

$$\Rightarrow (x-3)^2 + y^2 = (\sqrt{3})^2$$

SECTION - 3

- This section contains **SIX (06)** questions.
- Each question has **FOUR** options (A), (B), (C) and (D). **ONE OR MORE THAN ONE** of these four option(s) is (are) correct answer(s).
- For each question, choose the option(s) corresponding to (all) the correct answer(s).



- Answer to each question will be evaluated according to the following marking scheme:

Full Marks : +4 If only (all) the correct option(s) is(are) chosen;

Partial Marks : +3 If all the four options are correct but ONLY three options are chosen;

Partial Marks : +2 If three or more options are correct but ONLY two options are chosen, both of which are correct;

Partial Marks : +1 If two or more options are correct but ONLY one option is chosen and it is a correct option;

Zero Marks : 0 If unanswered;

Negative Marks : - 2 In all other cases.

- For example, in a question, if (A), (B) and (D) are the ONLY three options corresponding to correct answers, then

Choosing ONLY (A), (B) and (D) will get +4 marks;

Choosing ONLY (A) and (B) will get +2 marks;

Choosing ONLY (A) and (D) will get +2 marks;

Choosing ONLY (B) and (D) will get +2 marks;

Choosing ONLY (A) will get +1 mark;

Choosing ONLY (B) will get +1 mark;

Choosing ONLY (D) will get +1 mark;

Choosing no option(s) (i.e. the question is unanswered) will get 0 marks and choosing any other option(s) will get "2 marks.

11. A horizontal force F is applied at the center of mass of a cylindrical object of mass m and radius R , perpendicular to its axis as shown in the figure. The coefficient of friction between the object and the ground is μ . The center of mass of the object has an acceleration a . The acceleration due to gravity is g . Given that the object rolls without slipping, which of the following statement(s) is(are) correct?

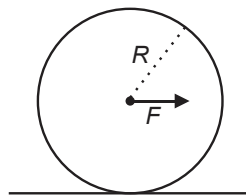

- (A) For the same F , the value of a does not depend on whether the cylinder is solid or hollow
- (B) For a solid cylinder, the maximum possible value of a is $2\mu g$
- (C) The magnitude of the frictional force on the object due to the ground is always μmg
- (D) For a thin-walled hollow cylinder, $a = \frac{F}{2m}$

Answer (B, D)



Sol. For solid cylinder,

$$F \times R = \frac{3}{2} m R^2 \times \left(\frac{a}{R} \right)$$

$$\Rightarrow a = \frac{2F}{3m}$$

For hollow cylinder,

$$F \times R = (2mR^2) \times \frac{a}{R}$$

$$\Rightarrow a = \frac{F}{2m}$$

For solid cylinder

$$f = F - m \times \frac{2F}{3m} = \frac{F}{3} \leq \mu mg$$

$$\Rightarrow F \leq 3\mu mg$$

$$\therefore a \leq \frac{2}{3m} \times (3\mu mg)$$

$$\Rightarrow a_{\max} = 2\mu g$$

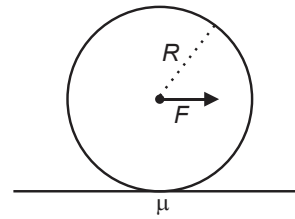

12. A wide slab consisting of two media of refractive indices n_1 and n_2 is placed in air as shown in the figure. A ray of light is incident from medium n_1 to n_2 at an angle θ , where $\sin \theta$ is slightly larger than $\frac{1}{n_1}$. Take refractive index of air as 1. Which of the following statement(s) is(are) correct?

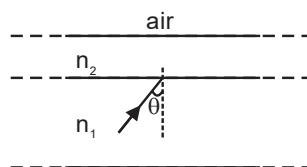

- (A) The light ray enters air if $n_2 = n_1$
- (B) The light ray is finally reflected back into the medium of refractive index n_1 if $n_2 < n_1$
- (C) The light ray is finally reflected back into the medium of refractive index n_1 if $n_2 > n_1$
- (D) The light ray is reflected back into the medium of refractive index n_1 if $n_2 = 1$

Answer (B, C, D)

Sol. $\sin \theta > \frac{1}{n_1}$... (i)

and, $n_1 \sin \theta = 1 \times \sin r$... (ii)

$\Rightarrow \sin r > 1$

\Rightarrow refraction into air is not possible.

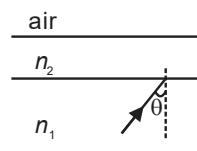

13. A particle of mass $M = 0.2$ kg is initially at rest in the xy -plane at a point $(x = -l, y = -h)$, where $l = 10$ m and $h = 1$ m. The particle is accelerated at time $t = 0$ with a constant acceleration $a = 10$ m/s² along the positive x -direction. Its angular momentum and torque with respect to the origin, in SI units, are represented by \vec{L} and $\vec{\tau}$, respectively. \hat{i} , \hat{j} and \hat{k} are unit vectors along the positive x , y and z -directions respectively. If $\hat{k} = \hat{i} \times \hat{j}$ then which of the following statement(s) is(are) correct?
- (A) The particle arrives at the point $(x = l, y = -h)$ at time $t = 2$ s
- (B) $\vec{\tau} = 2\hat{k}$ when the particle passes through the point $(x = l, y = -h)$
- (C) $\vec{L} = 4\hat{k}$ when the particle passes through the point $(x = l, y = -h)$
- (D) $\vec{\tau} = \hat{k}$ when the particle passes through the point $(x = 0, y = -h)$

Answer (A, B, C)

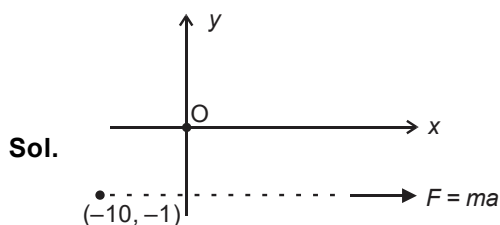

$$t = \sqrt{\frac{2 \times (20)}{10}} = 2 \text{ s}$$

$$\vec{\tau} = (0.2 \times 10 \times 1) \hat{k} = 2\hat{k}$$

$$\vec{L} = [0.2 \times (10 \times 2) \times 1] \hat{k} = 4\hat{k}$$

14. Which of the following statement(s) is(are) correct about the spectrum of hydrogen atom?
- (A) The ratio of the longest wavelength to the shortest wavelength in Balmer series is $\frac{9}{5}$
- (B) There is an overlap between the wavelength ranges of Balmer and Paschen series
- (C) The wavelengths of Lyman series are given by $\left(1 + \frac{1}{m^2}\right)\lambda_0$, where λ_0 is the shortest wavelength of Lyman series and m is an integer
- (D) The wavelength ranges of Lyman and Balmer series do not overlap

Answer (A, D)

Sol. For Balmer series :

$$\frac{1}{\lambda} = R \left(\frac{1}{2^2} - \frac{1}{n^2} \right) \quad n = 3, 4, 5, \dots$$

$$\frac{1}{\lambda_{\max}} = R \left(\frac{1}{4} - \frac{1}{9} \right)$$



$$\frac{1}{\lambda_{\min}} = R \left(\frac{1}{4} \right)$$

$$\Rightarrow \frac{\lambda_{\max}}{\lambda_{\min}} = \frac{9}{5}$$

For Lyman series

$$\frac{1}{\lambda} = R \left(1 - \frac{1}{n^2} \right) \quad n = 2, 3, 4, \dots$$

$$\frac{1}{\lambda_{\min}} = R$$

$$\Rightarrow \lambda = \frac{\lambda_0 n^2}{n^2 - 1}$$

15. A long straight wire carries a current, $I = 2$ ampere. A semi-circular conducting rod is placed beside it on two conducting parallel rails of negligible resistance. Both the rails are parallel to the wire. The wire, the rod and the rails lie in the same horizontal plane, as shown in the figure. Two ends of the semi-circular rod are at distances 1 cm and 4 cm from the wire. At time $t = 0$, the rod starts moving on the rails with a speed $v = 3.0$ m/s (see the figure).

A resistor $R = 1.4 \, \Omega$ and a capacitor $C_0 = 5.0 \, \mu\text{F}$ are connected in series between the rails. At time $t = 0$, C_0 is uncharged. Which of the following statement(s) is(are) correct? [$\mu_0 = 4\pi \times 10^{-7}$ SI units. Take $\ln 2 = 0.7$]

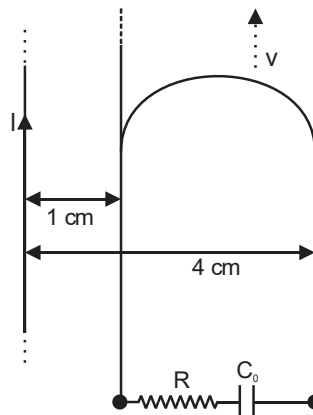

- (A) Maximum current through R is 1.2×10^{-6} ampere
- (B) Maximum current through R is 3.8×10^{-6} ampere
- (C) Maximum charge on capacitor C_0 is 8.4×10^{-12} coulomb
- (D) Maximum charge on capacitor C_0 is 2.4×10^{-12} coulomb

Answer (A, C)

Sol. Equivalent circuit of the given arrangement is :

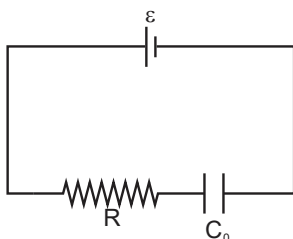

Where $\epsilon = \frac{\mu_0 I v}{2\pi} \ln \frac{b}{a}$

$= 1.68 \times 10^{-6} \text{ V}$

At $t = 0$, $i_{\max} = \frac{\epsilon}{R} = \frac{1.68 \times 10^{-6}}{1.4} = 1.2 \times 10^{-6} \text{ A}$

At $t = \infty$, $q_{\max} = C_0 \epsilon = 8.4 \times 10^{-12} \text{ C}$

16. A cylindrical tube, with its base as shown in the figure, is filled with water. It is moving down with a constant acceleration a along a fixed inclined plane with angle $\theta = 45^\circ$. P_1 and P_2 are pressures at points 1 and 2, respectively, located at the base of the tube. Let $\beta = \frac{(P_1 - P_2)}{(\rho g d)}$, where ρ is density of water, d is the inner diameter of the tube and g is the acceleration due to gravity. Which of the following statement(s) is(are) correct?

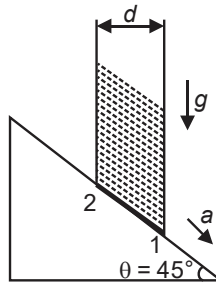

- (A) $\beta = 0$ when $a = \frac{g}{\sqrt{2}}$
- (B) $\beta > 0$ when $a = \frac{g}{\sqrt{2}}$
- (C) $\beta = \frac{\sqrt{2}-1}{\sqrt{2}}$ when $a = \frac{g}{2}$
- (D) $\beta = \frac{1}{\sqrt{2}}$ when $a = \frac{g}{2}$

Answer (A, C)

Sol. $P_1 = P_2 - \rho a \cos 45^\circ d + \rho(g - a \sin 45^\circ) d$

$\Rightarrow \frac{P_1 - P_2}{\rho g d} = 1 - \frac{\sqrt{2} a}{g}$

$\Rightarrow \beta = 0$ for $a = \frac{g}{\sqrt{2}}$

$\beta = \frac{\sqrt{2}-1}{\sqrt{2}}$ for $a = \frac{g}{2}$

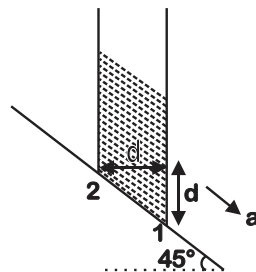

SECTION 4

- This section contains **THREE (03)** questions.
- The answer to each question is a **NON-NEGATIVE INTEGER**.
- For each question, enter the correct integer corresponding to the answer using the mouse and the on-screen virtual numeric keypad in the place designated to enter the answer.
- Answer to each question will be evaluated according to the following marking scheme:

Full Marks : +4 If ONLY the correct integer is entered

Zero Marks : 0 In all other cases.

17. An α -particle (mass 4 amu) and a singly charged sulfur ion (mass 32 amu) are initially at rest. They are accelerated through a potential V and then allowed to pass into a region of uniform magnetic field which is normal to the velocities of the particles. Within this region, the α -particle and the sulfur ion move in circular orbits of radii r_α and r_s , respectively. The ratio $\left(\frac{r_s}{r_\alpha}\right)$ is _____.

Answer (4)

Sol. $r = \frac{mv_0}{qB}$

$$\frac{1}{2}mv_0^2 = qV$$

$$r = \frac{\sqrt{2mqV}}{qB}$$

$$r = \frac{1}{B} \sqrt{\frac{2mV}{q}}$$

$$\frac{r_s}{r_\alpha} = \sqrt{\frac{m_s}{q_s}} \times \sqrt{\frac{q_\alpha}{m_\alpha}} = \sqrt{2} \times \sqrt{8}$$

$$\frac{r_s}{r_\alpha} = 4$$

18. A thin rod of mass M and length a is free to rotate in horizontal plane about a fixed vertical axis passing through point O. A thin circular disc of mass M and of radius $\frac{a}{4}$ is pivoted on this rod with its center at a distance $\frac{a}{4}$ from the free end so that it can rotate freely about its vertical axis, as shown in the figure. Assume that both the rod and the disc have uniform density and they remain horizontal during the motion. An outside stationary observer finds the rod rotating with an angular velocity Ω and the disc rotating about its vertical axis with angular velocity 4Ω . The total angular momentum of the system about the point O is $\left(\frac{Ma^2\Omega}{48}\right)^n$. The value of n is _____.

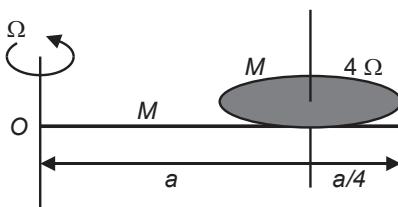

Answer (49)

Sol. $L_s = L_{\text{disc}} + L_{\text{rod}}$

$$L_{\text{disc}} = \vec{r} \times \vec{p} + I_{\text{cm}} 4\Omega$$

$$= \frac{Ma^2}{32} \times 4\Omega + \frac{3a}{4} \times \frac{3a}{4} \times M\Omega$$

$$= \frac{11}{16} Ma^2 \Omega$$

$$L_{\text{rod}} = \frac{Ma^2 \Omega}{3}$$

$$L_{\text{system}} = \left(\frac{Ma^2}{3} \Omega + \frac{11}{16} Ma^2 \Omega \right)$$

$$= \frac{49}{48} Ma^2 \Omega$$

n = 49

19. A small object is placed at the center of a large evacuated hollow spherical container. Assume that the container is maintained at 0 K. At time $t = 0$, the temperature of the object is 200 K. The temperature of the object becomes 100 K at $t = t_1$ and 50 K at $t = t_2$. Assume the object and the container to be ideal black bodies.

The heat capacity of the object does not depend on temperature. The ratio $\left(\frac{t_2}{t_1} \right)$ is _____.

Answer (9)

Sol. Heat radiated = $e\sigma AT^4$
 $= KT^4$

$$-mS \frac{dT}{dt} = KT^4$$

$$-mS \int_{200}^{100} \frac{dT}{T^4} = Kt_1$$

$$t_1 = \frac{1}{K_1} \left[\frac{1}{100^3} - \frac{1}{200^3} \right] = \frac{1}{K_1} \left[\frac{7}{200^3} \right]$$

$$t_2 = \frac{1}{K_1} \left[\frac{1}{50^3} - \frac{1}{200^3} \right] = \frac{1}{K_1} \left[\frac{63}{200^3} \right]$$

$$\frac{t_2}{t_1} = 9$$



PART-II : CHEMISTRY

SECTION - 1

- This section contains **FOUR (04)** questions.
- Each question has **FOUR** options (A), (B), (C) and (D). **ONLY ONE** of these four options is the correct answer.
- For each question, choose the option corresponding to the correct answer.
- Answer to each question will be evaluated according to the following marking scheme:

Full Marks : +3 If ONLY the correct option is chosen;

Zero Marks : 0 If none of the options is chosen (i.e. the question is unanswered);

Negative Marks : -1 In all other cases.

1. The major product formed in the following reaction is

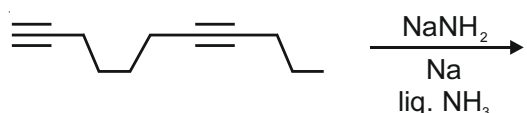

- (A) (B)
- (C) (D)

Answer (B)

Sol. It is a case of Birch reduction. Alkynes on reaction with alkali metal in liq. NH_3 gives trans-alkene. But terminal alkynes do not get reduced.

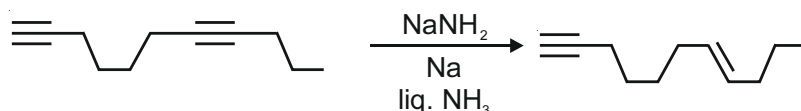

2. Among the following, the conformation that corresponds to the most stable conformation of *meso*-butane-2,3-diol is

- (A)
- (B)
- (C)
- (D)

Answer (B)



Sol. Meso compounds have plane of symmetry. In case of butan-2, 3-diol, gauche form is the most stable due to intra-molecular H-bonding.

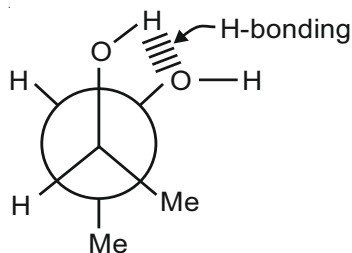

3. For the given close packed structure of a salt made of cation X and anion Y shown below (ions of only one face are shown for clarity), the packing fraction is approximately (packing fraction = $\frac{\text{packing efficiency}}{100}$)

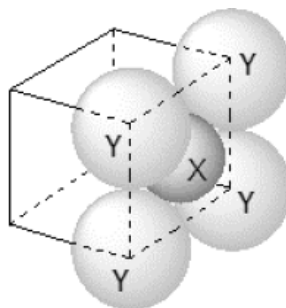

(A) 0.74

(C) 0.52

(B) 0.63

(D) 0.48

Answer (B)

Sol. a = edge length of unit cell

$$2r_y = a$$

$$2(r_x + r_y) = \sqrt{2}a$$

$$2r_x + a = \sqrt{2}a$$

$$2r_x = a(\sqrt{2} - 1)$$

$$r_x = 0.207 a$$

$$\text{Packing fraction} = \frac{3 \times \text{vol. of } x + \text{vol. of } y}{\text{vol. of unit cell}}$$

$$= \frac{3 \times \frac{4}{3} \times \pi r_x^3 + \frac{4}{3} \times \pi \times r_y^3}{a^3}$$

$$= \frac{4 \times \pi \times (0.207a)^3 + \frac{4}{3} \times \pi \times (0.5a)^3}{a^3}$$

$$\approx 0.63$$

4. The calculated spin only magnetic moments of $[\text{Cr}(\text{NH}_3)_6]^{3+}$ and $[\text{CuF}_6]^{3-}$ in BM, respectively, are (Atomic numbers of Cr and Cu are 24 and 29, respectively)

(A) 3.87 and 2.84

(B) 4.90 and 1.73

(C) 3.87 and 1.73

(D) 4.90 and 2.84

Answer (A)

Sol. $[\text{Cr}(\text{NH}_3)_6]^{3+} = \text{Cr}^{3+}$

$$\text{Cr}^{3+} = 3d^3 4s^0$$

It has 3 unpaired electrons

$$\mu = \sqrt{n(n+2)} \text{ BM}$$

$$= \sqrt{3(3+2)} \text{ BM}$$

$$= 3.87 \text{ BM}$$

$[\text{CuF}_6]^{3-} = \text{Cu}^{+3}$

$$\text{Cu}^{+3} = 3d^8 4s^0$$

It has 2 unpaired electrons

$$\mu = \sqrt{2(2+2)} \text{ BM}$$

$$= 2.84 \text{ BM}$$

SECTION - 2

- This section contains **THREE (03)** question stems.
- There are **TWO (02)** questions corresponding to each question stem.
- The answer to each question is a **NUMERICAL VALUE**.
- For each question, enter the correct numerical value corresponding to the answer in the designated place using the mouse and the on-screen virtual numeric keypad.
- If the numerical value has more than two decimal places, **truncate/round-off** the value to **TWO** decimal places.
- Answer to each question will be evaluated according to the following marking scheme:

Full Marks : +2 If ONLY the correct numerical value is entered at the designated place;

Zero Marks : 0 In all other cases.

Question stem for Question Nos. 5 and 6

Question Stem

For the following reaction scheme, percentage yields are given along the arrow:

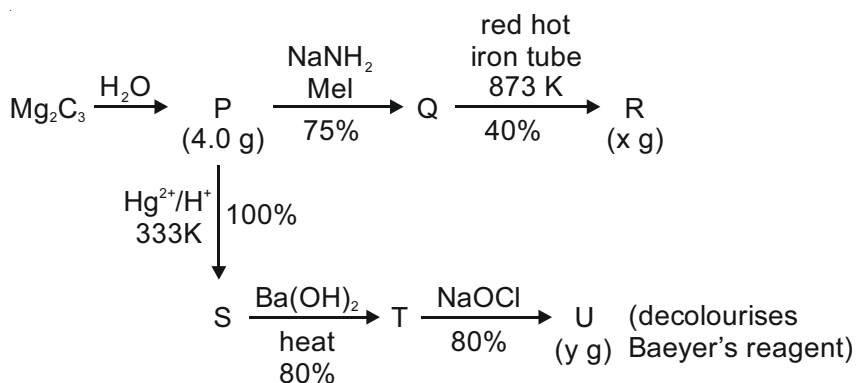

$x \text{ g}$ and $y \text{ g}$ are mass of R and U, respectively.

(Use : Molar mass (in g mol^{-1}) of H, C and O as 1, 12 and 16, respectively)

5. The value of x is _____.

Answer (1.62)

6. The value of y is _____.

Answer (3.20)



Sol. of Q. No. 5 and 6

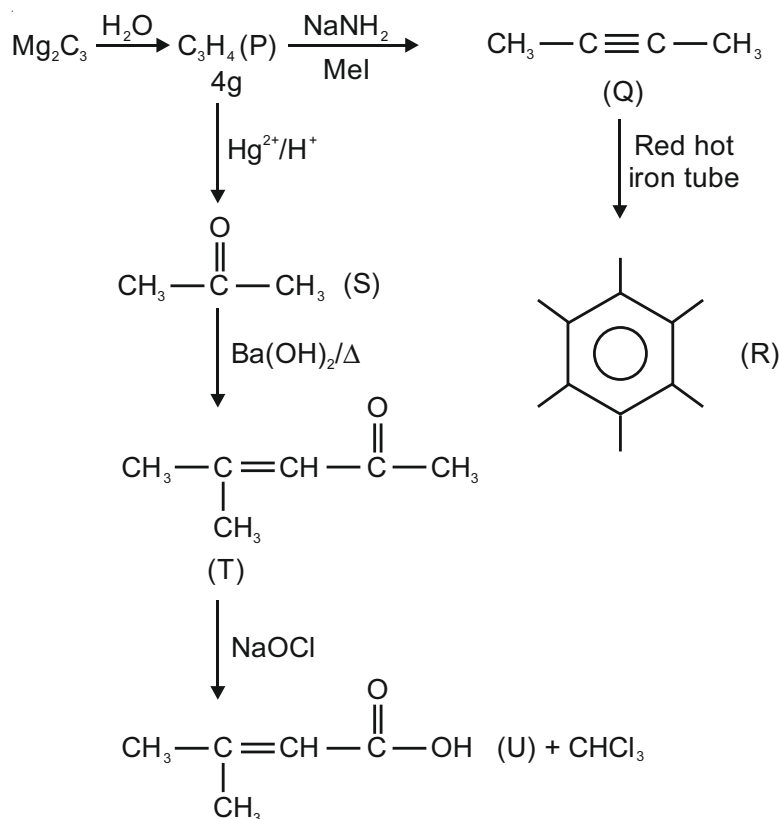

4 g of $\text{C}_3\text{H}_4 = 0.1 \text{ mol}$

From 0.1 mol of P, 0.01 mol of R will be produced

$\Rightarrow 1.62 \text{ g}$ of R is produced

From 0.1 mol of P, 0.032 mol of U is produced

$= 3.2 \text{ g}$ of U is produced

Question stem for Question Nos. 7 and 8

Question Stem

For the reaction, $\text{X(s)} \rightleftharpoons \text{Y(s)} + \text{Z(g)}$, the plot of $\ln \frac{p_z}{p^\ominus}$ versus $\frac{10^4}{T}$ is given below (in solid line), where p_z is the pressure (in bar) of the gas Z at temperature T and $p^\ominus = 1 \text{ bar}$.

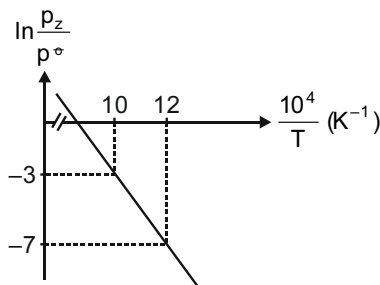

(Given, $\frac{d(\ln K)}{d\left(\frac{1}{T}\right)} = -\frac{\Delta H^\ominus}{R}$, where the equilibrium constant, $K = \frac{p_z}{p^\ominus}$ and the gas constant, $R = 8.314 \text{ J K}^{-1} \text{ mol}^{-1}$)

7. The value of standard enthalpy, ΔH° (in kJ mol^{-1}) for the given reaction is _____.

Answer (166.28)

Sol. $X(s) \rightleftharpoons Y(s) + Z(g)$

$$\text{Given } K = \frac{p_z}{p^\ominus}$$

$$\ln K = \ln A - \frac{\Delta H^\circ}{RT}$$

$$\Rightarrow \ln \frac{p_z}{p^\ominus} = \ln A - \frac{\Delta H}{RT}$$

$$\text{Slope of } \ln \frac{p_z}{p^\ominus} \text{ vs } \frac{1}{T} \text{ is } \frac{d \left[\ln \left(\frac{p_z}{p^\ominus} \right) \right]}{d \left(\frac{1}{T} \right)} = \frac{-\Delta H^\circ}{R}$$

$$\text{From the graph, we have } \frac{-\Delta H^\circ}{R} = -2 \times 10^4$$

$$\Rightarrow \Delta H^\circ = 2 \times 10^4 \times 8.314 \text{ J}$$

$$\Delta H^\circ = 166.28 \text{ kJ mol}^{-1}$$

8. The value of ΔS° (in $\text{J K}^{-1} \text{ mol}^{-1}$) for the given reaction, at 1000 K is _____.

Answer (141.34)

Sol. $-RT \ln K = \Delta G^\circ = \Delta H^\circ - T \Delta S^\circ$

$$\ln k = -\frac{\Delta H^\circ}{RT} + \frac{\Delta S^\circ}{R}$$

$$\frac{\Delta S^\circ}{R} = 17$$

$$\Delta S^\circ = 17R$$

$$= 141.338 \text{ J K}^{-1}$$

Question stem for Question Nos. 9 and 10

Question Stem

The boiling point of water in a 0.1 molal silver nitrate solution (solution A) is $x^\circ\text{C}$. To this solution A, an equal volume of 0.1 molal aqueous barium chloride solution is added to make a new solution B. The difference in the boiling points of water in the two solutions A and B is $y \times 10^{-2} \text{ }^\circ\text{C}$.

(Assume: Densities of the solutions A and B are the same as that of water and the soluble salts dissociate completely.)

Use: Molal elevation constant (Ebullioscopic constant), $K_b = 0.5 \text{ K kg mol}^{-1}$; Boiling point of pure water as 100°C .)

9. The value of x is _____.

Answer (100.1)

10. The value of $|y|$ is _____.

Answer (2.5)



Sol. of Q. No. 9 and 10

Given molality of AgNO_3 solution is 0.1 molal (solution-A)

$$\Delta T_b = i k_b m$$

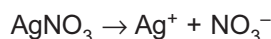

van't Hoff factor (i) for $\text{AgNO}_3 = 2$

$$\Delta T_b = 2 \times 0.5 \times 0.1$$

$$(T_s - T^\circ) = 0.1$$

$$(T_s)_A = 100.1^\circ\text{C}, \text{ so } x = 100.1$$

Now solution-A of equal volume is mixed with 0.1 molal BaCl_2 solution to get solution-B. AgNO_3 reacts with BaCl_2 to form $\text{AgCl}(s)$.

0.1 mole of AgNO_3 present in 1000 gram solvent or 1017 gram or 1017 mL solution,

milli moles of AgNO_3 in V ml 0.1 molal solution is nearly 0.1 V. Similarly in BaCl_2 .

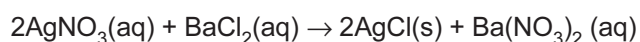

0.1 V	0.1 V	0	0
0	0.05 V	0.1 V	0.05 V

$$\Delta T_b = \left[\frac{0.05V \times 3}{2V} + \frac{0.05V \times 3}{2V} \right] \times 0.5 = 0.075$$

$$(T_s)_B = 100.075^\circ\text{C}$$

$$(T_s)_A - (T_s)_B = 100.1 - 100.075 = 0.025^\circ\text{C}$$

$$= 2.5 \times 10^{-2} \text{ }^\circ\text{C}$$

So $x = 100.1$ and $|y| = 2.5$

SECTION - 3

- This section contains **SIX (06)** questions.
- Each question has **FOUR** options (A), (B), (C) & (D). **ONE OR MORE THAN ONE** of these four option(s) is(are) correct answer(s).
- For each question, choose the option(s) corresponding to (all) the correct answer(s).
- Answer to each question will be evaluated according to the following marking scheme:

<i>Full Marks</i>	: +4	If only (all) the correct option(s) is(are) chosen;
<i>Partial Marks</i>	: +3	If all the four options are correct but ONLY three options are chosen;
<i>Partial Marks</i>	: +2	If three or more options are correct but ONLY two options are chosen, both of which are correct;
<i>Partial Marks</i>	: +1	If two or more options are correct but ONLY one option is chosen and it is a correct option;
<i>Zero Marks</i>	: 0	If none of the options is chosen (i.e. the question is unanswered);
<i>Negative Marks</i>	: -2	In all other cases.
- For example, in a question, if (A), (B) and (D) are the ONLY three options corresponding to correct answers, then
 - choosing ONLY (A), (B) and (D) will get +4 marks;
 - choosing ONLY (A) and (B) will get +2 marks;
 - choosing ONLY (A) and (D) will get +2 marks;



choosing ONLY (B) and (D) will get +2 marks;

choosing ONLY (A) will get +1 mark;

choosing ONLY (B) will get +1 mark;

choosing ONLY (D) will get +1 mark;

choosing no option(s) (i.e., the question is unanswered) will get 0 marks and

choosing any other options will get -2 marks.

11. Given:

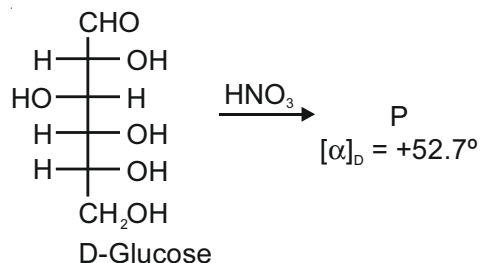

The compound(s), which on reaction with HNO_3 will give the product having degree of rotation, $[\alpha]_D = -52.7^\circ$ is(are)

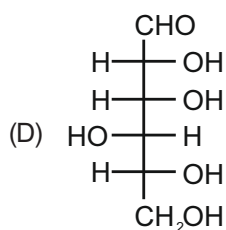
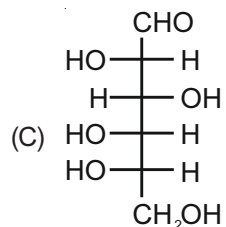
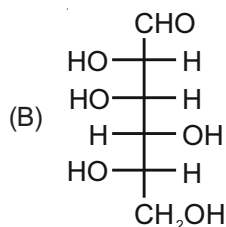
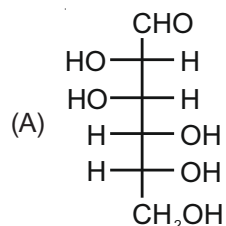

Answer (C, D)

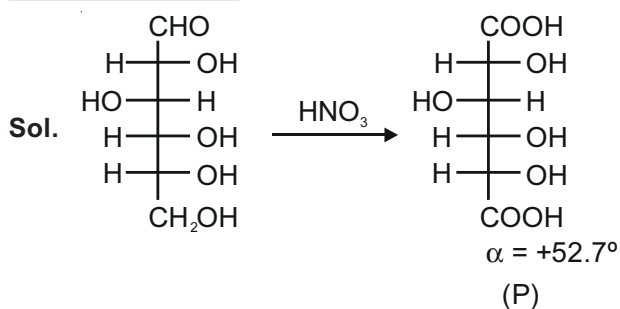

The enantiomer of (P) will have -52.7° rotation. So the reactant must be an isomer of D-glucose which can give the mirror image of (P)

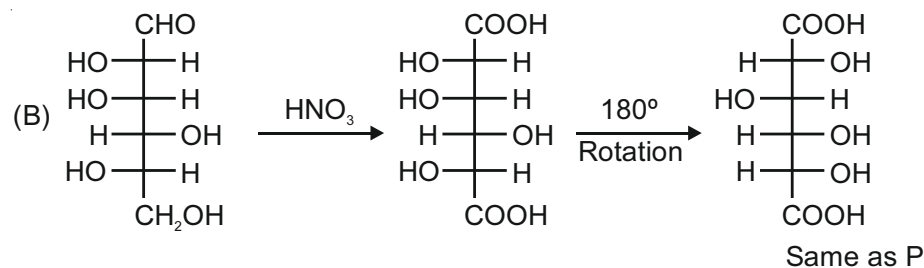

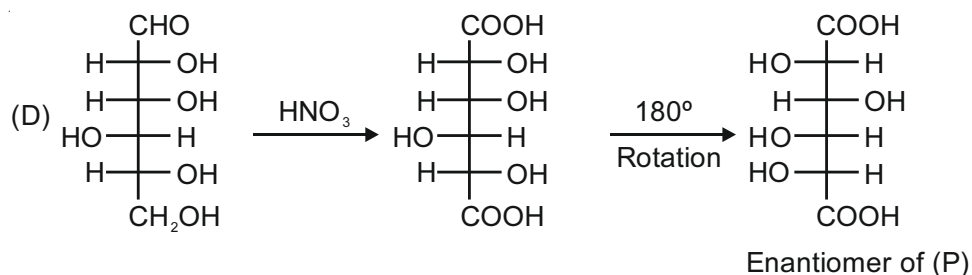
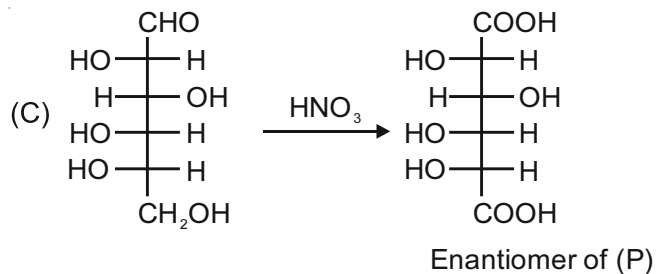

So answer must be C and D

12. The reaction of Q with PhSNa yields an organic compound (major product) that gives positive Carius test on treatment with Na_2O_2 followed by addition of BaCl_2 . The correct option(s) for Q is(are)

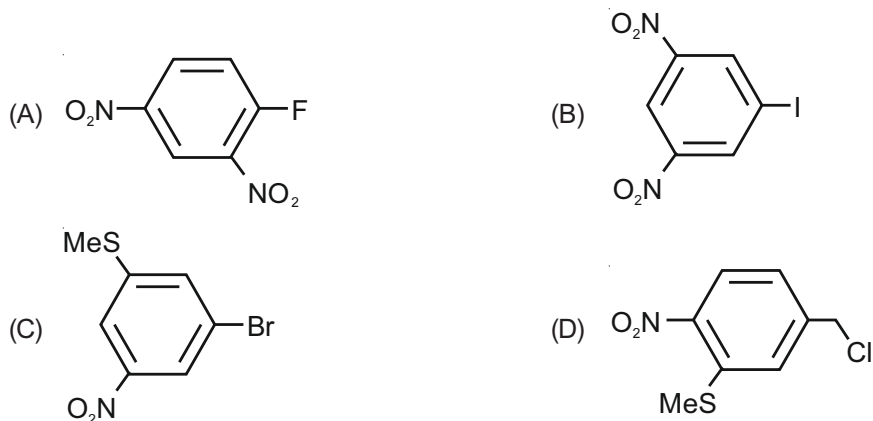

Answer (A, D)

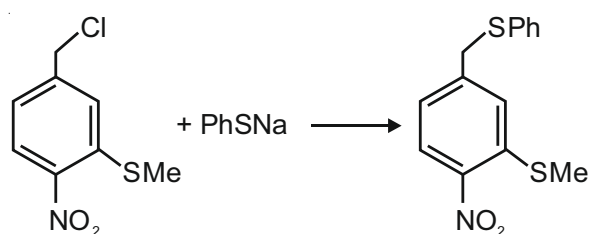
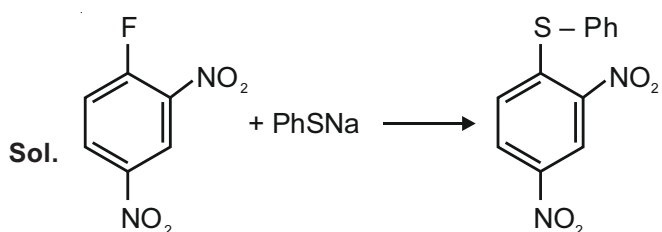

Answer should be (A) and (D)

Compounds given in option - B and C do not react with PhSNa.



13. The correct statement(s) related to colloids is(are)
- (A) The process of precipitating colloidal sol by an electrolyte is called peptization
 - (B) Colloidal solution freezes at higher temperature than the true solution at the same concentration
 - (C) Surfactants form micelle above critical micelle concentration (CMC). CMC depends on temperature
 - (D) Micelles are macromolecular colloids

Answer (B, C)

Sol. Select the correct statements.

- (A) The process of precipitating colloidal sol by an electrolyte is called peptization - False, (It is process of converting precipitate into colloid)
 - (B) Colloidal solution freezes at a higher temperature than the true solution at the same concentration - True (colligative properties)
 - (C) Surfactants form miscelle above critical miscelle concentration (CMC). CMC depends on temperature - True
 - (D) Miscelles are macromolecular colloids - False, As miscelles are associated colloids.
14. An ideal gas undergoes a reversible isothermal expansion from state I to state II followed by a reversible adiabatic expansion from state II to state III. The correct plot(s) representing the changes from state I to state III is(are)
(p: pressure, V: volume, T: temperature, H: enthalpy, S: entropy)

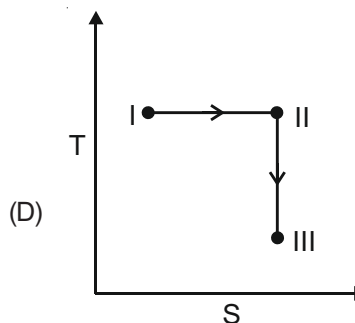
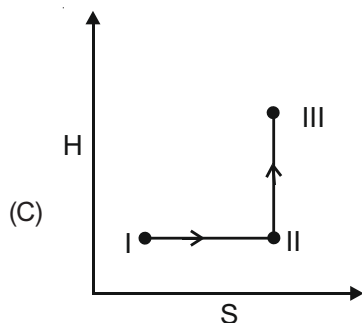
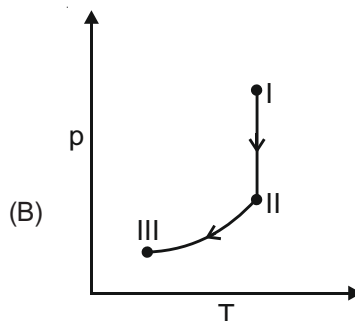
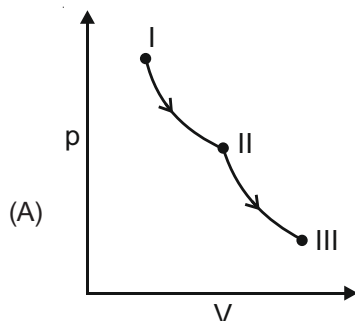

Answer (A, B, D)

Sol. I → II → reversible, isothermal expansion,
 T → constant, $\Delta V \rightarrow +ve$, $\Delta S \rightarrow +ve$ $\Delta H \Rightarrow 0$
 II → III → Reversible, adiabatic expansion
 $Q = 0$, $\Delta V \rightarrow +ve$, $\Delta S \rightarrow 0$

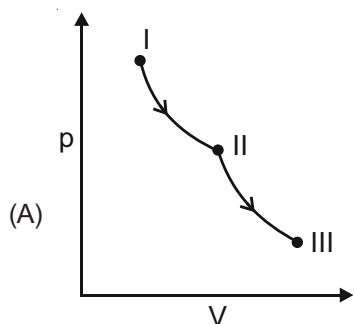

-ve slope - isothermal < adiabatic
 I → II → Isothermal
 II → III → Adiabatic

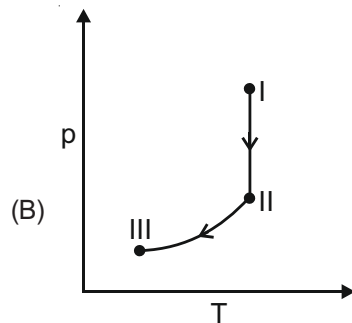

I → II → T constant
II → III → adiabatic

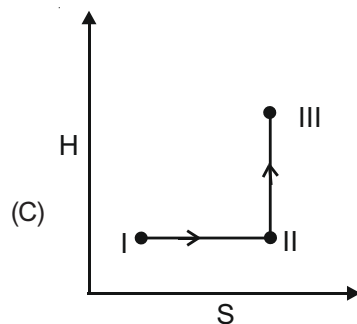

I → II → $\Delta S \rightarrow +ve, \Delta H \Rightarrow 0$
II → III → $\Delta S \rightarrow 0, \Delta H \rightarrow -ve$

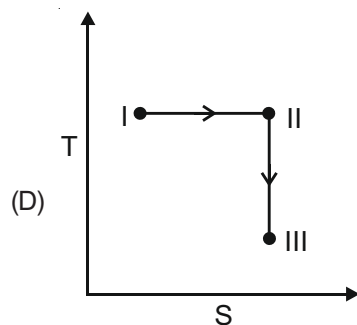

I → II → $\Delta S \rightarrow +ve, \Delta T = 0$
II → III → $\Delta S \rightarrow 0$

15. The correct statement(s) related to the metal extraction processes is(are)

- (A) A mixture of PbS and PbO undergoes self-reduction to produce Pb and SO₂.
- (B) In the extraction process of copper from copper pyrites, silica is added to produce copper silicate
- (C) Partial oxidation of sulphide ore of copper by roasting, followed by self-reduction produces blister copper
- (D) In cyanide process, zinc powder is utilized to precipitate gold from Na[Au(CN)₂]

Answer (A, C, D)



Self reduction is taking place between PbS and PbO.

In the Bessemer converter : The raw material for the Bessemer converter is matte, i.e., Cu₂S + FeS (little). Here air blasting is initially done for slag formation and SiO₂ is added from external source.

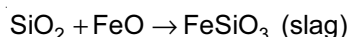
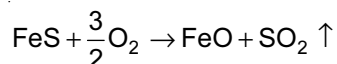

During slag formation, the characteristic green flame is observed at the mouth of the Bessemer converter which indicates the presence of iron in the form of FeO. Disappearance of this green flame indicates that the slag formation is complete. Then air blasting is stopped and slag is removed.

Again air blasting is restarted for partial roasting before self reduction, until two-thirds of Cu₂S is converted into Cu₂O. After this, only heating is continued for the self reduction process.



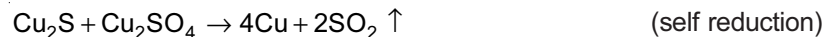
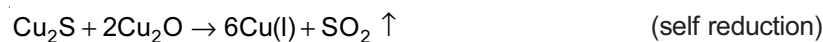
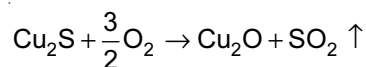

Thus the molten Cu obtained is poured into large container and allowed to cool and during cooling the dissolved SO_2 comes up to the surface and forms blisters. It is known as blister copper.

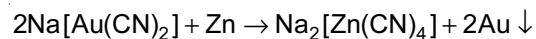

16. A mixture of two salts is used to prepare a solution S, which gives the following results:

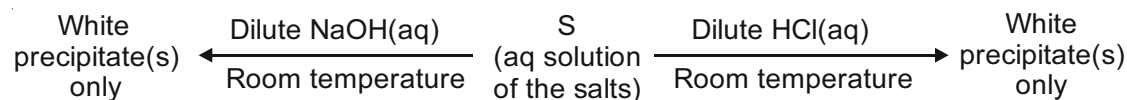

The correct option(s) for the salt mixture is(are)

- (A) $\text{Pb}(\text{NO}_3)_2$ and $\text{Zn}(\text{NO}_3)_2$
 (B) $\text{Pb}(\text{NO}_3)_2$ and $\text{Bi}(\text{NO}_3)_3$
 (C) AgNO_3 and $\text{Bi}(\text{NO}_3)_3$
 (D) $\text{Pb}(\text{NO}_3)_2$ and $\text{Hg}(\text{NO}_3)_2$

Answer (A, B)

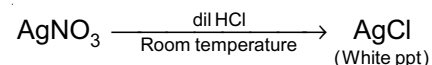
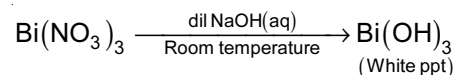
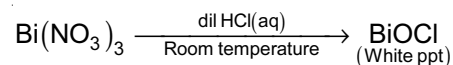
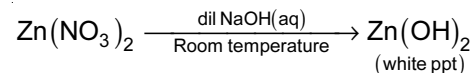
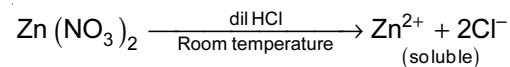
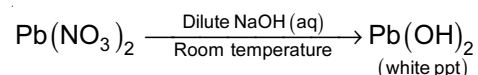
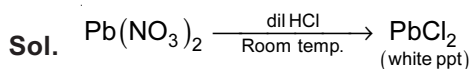

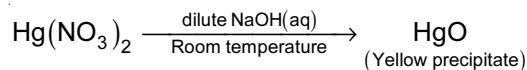
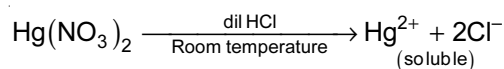
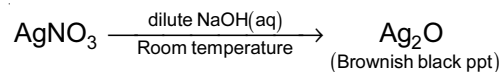

SECTION - 4

- This section contains **THREE (03)** questions.
- The answer to each question is a **NON-NEGATIVE INTEGER**.
- For each question, enter the correct integer corresponding to the answer using the mouse and the on-screen virtual numeric keypad in the place designated to enter the answer.
- Answer to each question will be evaluated according to the following marking scheme:

Full Marks : +4 If **ONLY** the correct numerical value is entered.

Zero Marks : 0 In all other cases.

17. The maximum number of possible isomers (including stereoisomers) which may be formed on *mono*-bromination of 1-methylcyclohex-1-ene using Br_2 and UV light is _____.

Answer (13)

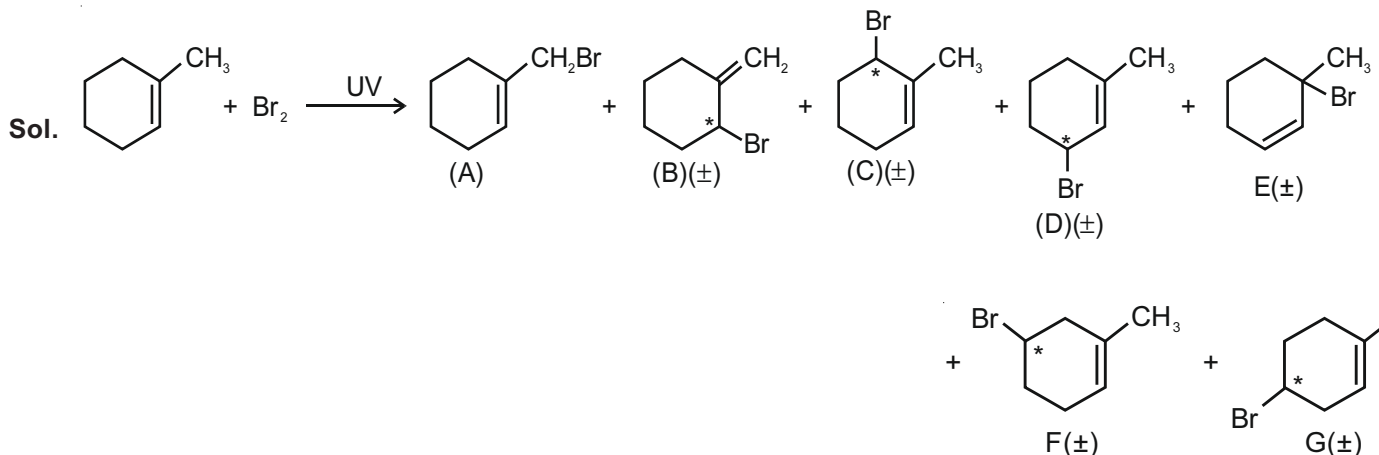

Monobromination of 1-methylcyclohexene in presence of UV light proceeds by free radical mechanism. The allyl radicals are formed which are stabilised by resonance. The secondary alkyl radicals are also formed which are stabilised by hyperconjugation. Of the seven products formed, six of them are optically active. So, 13 possible isomers are formed.

18. In the reaction given below, the total number of atoms having sp^2 hybridization in the major product P is _____.

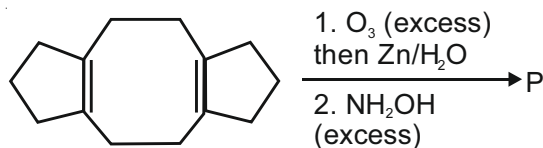

Answer (12)

Sol.

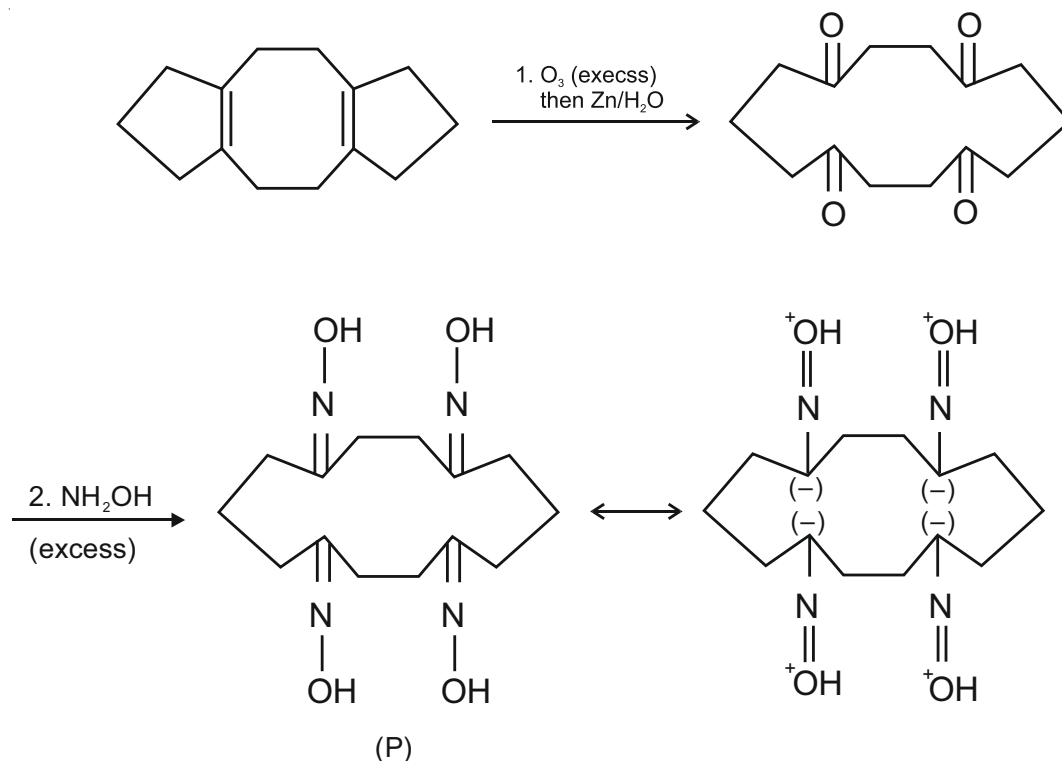

The total number of atoms having sp^2 hybridisation in the major product (P) = 12

This includes 4 C-atoms, 4 N-atoms and 4 O-atoms.

19. The total number of possible isomers for $[Pt(NH_3)_4Cl_2]Br_2$ is

Answer (6)

Sol. The given complex $[Pt(NH_3)_4Cl_2]Br_2$ has three ionisation isomers and each of them has two geometrical isomers.

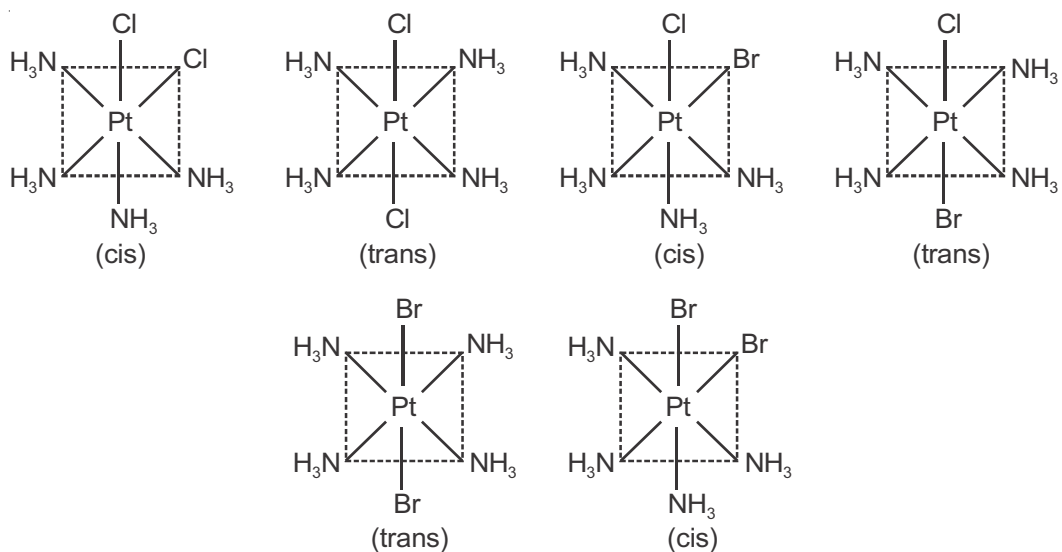

SECTION - 1

- This section contains **FOUR (04)** questions.
- Each question has **FOUR** options (A), (B), (C) and (D). **ONLY ONE** of these four options is the correct answer.
- For each question, choose the option corresponding to the correct answer.
- Answer to each question will be evaluated according to the following marking scheme:

Full Marks : +3 If **ONLY** the correct option is chosen;

Zero Marks : 0 If none of the options is chosen (i.e. the question is unanswered);

Negative Marks : -1 In all other cases.

1. Consider a triangle Δ whose two sides lie on the x -axis and the line $x + y + 1 = 0$. If the orthocentre of Δ is $(1, 1)$, then the equation of the circle passing through the vertices of the triangle Δ is
- (A) $x^2 + y^2 - 3x + y = 0$ (B) $x^2 + y^2 + x + 3y = 0$
 (C) $x^2 + y^2 + 2y - 1 = 0$ (D) $x^2 + y^2 + x + y = 0$

Answer (B)

Sol. As we know mirror image of orthocentre lie on circumcircle.

Image of $(1, 1)$ in x -axis is $(1, -1)$

Image of $(1, 1)$ in $x + y + 1 = 0$ is $(-2, -2)$.

\therefore The required circle will be passing through both $(1, -1)$ and $(-2, -2)$.

\therefore Only $x^2 + y^2 + x + 3y = 0$ satisfy both.

2. The area of the region

$$\left\{ (x, y) : 0 \leq x \leq \frac{9}{4}, \quad 0 \leq y \leq 1, \quad x \geq 3y, \quad x + y \geq 2 \right\}$$

is

- (A) $\frac{11}{32}$ (B) $\frac{35}{96}$
 (C) $\frac{37}{96}$ (D) $\frac{13}{32}$

Answer (A)

Sol. Rough sketch of required region is

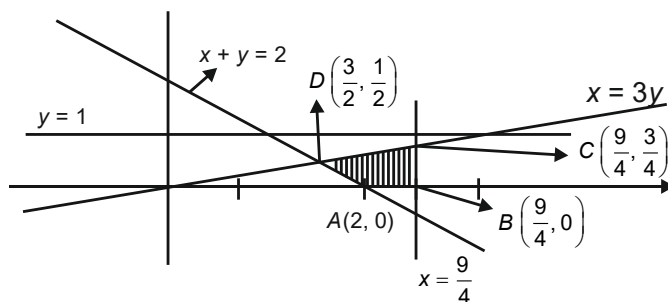

4. Let $\theta_1, \theta_2, \dots, \theta_{10}$ be positive valued angles (in radian) such that $\theta_1 + \theta_2 + \dots + \theta_{10} = 2\pi$. Define the complex numbers $z_1 = e^{i\theta_1}, z_k = z_{k-1}e^{i\theta_k}$ for $k = 2, 3, \dots, 10$, where $i = \sqrt{-1}$. Consider the statement P and Q given below:

$$P : |z_2 - z_1| + |z_3 - z_2| + \dots + |z_{10} - z_9| + |z_1 - z_{10}| \leq 2\pi$$

$$Q : |z_2^2 - z_1^2| + |z_3^2 - z_2^2| + \dots + |z_{10}^2 - z_9^2| + |z_1^2 - z_{10}^2| \leq 4\pi$$

Then,

- (A) P is **TRUE** and Q is **FALSE**
 (B) Q is **TRUE** and P is **FALSE**
 (C) Both P and Q are **TRUE**
 (D) Both P and Q are **FALSE**

Answer (C)

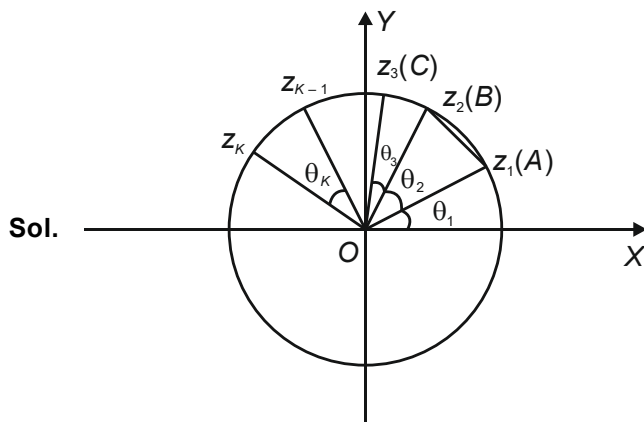

$$|z_2 - z_1| = \text{length of line } AB \leq \text{length of arc } AB$$

$$|z_3 - z_2| = \text{length of line } BC \leq \text{length of arc } BC$$

\therefore Sum of length of these 10 lines \leq Sum of length of arcs (i.e. 2π)

(As $(\theta_1 + \theta_2 + \dots + \theta_{10}) = 2\pi$)

$$\therefore |z_2 - z_1| + |z_3 - z_2| + \dots + |z_1 - z_{10}| \leq 2\pi$$

$$\text{And } |z_k^2 - z_{k-1}^2| = |z_k - z_{k-1}| |z_k + z_{k-1}|$$

$$\text{As we know } |z_k + z_{k-1}| \leq |z_k| + |z_{k-1}| \leq 2$$

$$\begin{aligned} |z_2^2 - z_1^2| + |z_3^2 - z_2^2| + \dots + |z_1^2 - z_{10}^2| &\leq 2 (|z_2 - z_1| + |z_3 - z_2| + \dots + |z_1 - z_{10}|) \\ &\leq 2 (2\pi) \end{aligned}$$

\therefore Both (P) and (Q) are true.



SECTION - 2

- This section contains **THREE (03)** question stems.
- There are **TWO (02)** questions corresponding to each question stem.
- The answer to each question is a **NUMERICAL VALUE**.
- For each question, enter the correct numerical value corresponding to the answer in the designated place using the mouse and the on-screen virtual numerical keypad.
- If the numerical value has more than two decimal places, **truncate/round-off** the value to **TWO** decimal places.
- Answer to each question will be evaluated according to the following marking scheme:

Full Marks : +2 If ONLY the correct numerical value is entered at the designated place;

Zero Marks : 0 In all other cases.

Question Stem for Question Nos. 5 and 6

Question Stem

Three numbers are chosen at random, one after another with replacement, from the set $S = \{1, 2, 3, \dots, 100\}$. Let p_1 be the probability that the maximum of chosen numbers is at least 81 and p_2 be the probability that the minimum of chosen numbers is at most 40.

5. The value of $\frac{625}{4} p_1$ is _____.

Answer (76.25)

Sol. For p_1 , we need to remove the cases when all three numbers are less than or equal to 80.

$$\text{So, } p_1 = 1 - \left(\frac{80}{100}\right)^3 = \frac{61}{125}$$

$$\text{So, } \frac{625}{4} p_1 = \frac{625}{4} \times \frac{61}{125} = \frac{305}{4} = 76.25$$

6. The value of $\frac{125}{4} p_2$ is _____.

Answer (24.50)

Sol. For p_2 , we need to remove the cases when all three numbers are greater than 40.

$$\text{So, } p_2 = 1 - \left(\frac{60}{100}\right)^3 = \frac{98}{125}$$

$$\text{So, } \frac{125}{4} p_2 = \frac{125}{4} \times \frac{98}{125} = 24.50$$



Question Stem

Let α , β and γ be real numbers such that the system of linear equations

$$x + 2y + 3z = \alpha$$

$$4x + 5y + 6z = \beta$$

$$7x + 8y + 9z = \gamma - 1$$

is consistent. Let $|M|$ represent the determinant of the matrix

$$M = \begin{bmatrix} \alpha & 2 & \gamma \\ \beta & 1 & 0 \\ -1 & 0 & 1 \end{bmatrix}$$

Let P be the plane containing all those (α, β, γ) for which the above system of linear equations is consistent, and D be the **square** of the distance of the point $(0, 1, 0)$ from the plane P .

7. The value of $|M|$ is _____.

Answer (1)

8. The value of D is _____.

Answer (1.50)

Sol. Solution for Q 7 and 8

$$\Delta = \begin{vmatrix} 1 & 2 & 3 \\ 4 & 5 & 6 \\ 7 & 8 & 9 \end{vmatrix} = 0$$

Given system of equation will be consistent even if $\alpha = \beta = \gamma - 1 = 0$, i.e. equations will form homogeneous system.

So, $\alpha = 0$, $\beta = 0$, $\gamma = 1$

$$M = \begin{vmatrix} 0 & 2 & 1 \\ 0 & 1 & 0 \\ -1 & 0 & 1 \end{vmatrix} = -1(-1) = +1$$

As given equations are consistent

$$x + 2y + 3z - \alpha = 0 \quad \dots P_1$$

$$4x + 5y + 6z - \beta = 0 \quad \dots P_2$$

$$7x + 8y + 9z - (\gamma - 1) = 0 \quad \dots P_3$$

For some scalar λ and μ

$$\mu P_1 + \lambda P_2 = P_3$$

$$\mu(x + 2y + 3z - \alpha) + \lambda(4x + 5y + 6z - \beta) = 7x + 8y + 9z - (\gamma - 1)$$

Comparing coefficients

$$\mu + 4\lambda = 7, \quad 2\mu + 5\lambda = 8, \quad 3\mu + 6\lambda = 9$$

$\lambda = 2$ and $\mu = -1$ satisfy all these conditions

comparing constant terms,

$$-\alpha\mu - \beta\lambda = -(\gamma - 1)$$

$$\alpha - 2\beta + \gamma = 1$$

So equation of plane is

$$x - 2y + z = 1$$

$$\text{Distance from } (0, 1, 0) = \left| \frac{-2 - 1}{\sqrt{6}} \right| = \frac{3}{\sqrt{6}}$$

$$D = \left(\frac{3}{\sqrt{6}} \right)^2 = \frac{3}{2} = 1.50$$

Question Stem for Question Nos. 9 and 10

Question Stem

Consider the lines L_1 and L_2 defined by

$$L_1 : x\sqrt{2} + y - 1 = 0 \text{ and } L_2 : x\sqrt{2} - y + 1 = 0$$

For a fixed constant λ , let C be the locus of a point P such that the product of the distance of P from L_1 and the distance of P from L_2 is λ^2 . The line $y = 2x + 1$ meets C at two points R and S , where the distance between R and S is $\sqrt{270}$.

Let the perpendicular bisector of RS meet C at two distinct points R' and S' . Let D be the square of the distance between R' and S' .

9. The value of λ^2 is _____.

Answer (9)

10. The value of D is _____.

Answer (77.14)

Sol. Solution for Q 9 and 10

$$C : \left| \frac{x\sqrt{2} + y - 1}{\sqrt{3}} \right| \left| \frac{x\sqrt{2} - y + 1}{\sqrt{3}} \right| = \lambda^2$$

$$\Rightarrow C : |2x^2 - (y - 1)^2| = 3\lambda^2$$

C cuts $y - 1 = 2x$ at $R(x_1, y_1)$ and $S(x_2, y_2)$

$$\text{So, } |2x^2 - 4x^2| = 3\lambda^2 \Rightarrow x = \pm \sqrt{\frac{3}{2}} |\lambda|$$

$$\text{So, } |x_1 - x_2| = \sqrt{6} |\lambda| \text{ and } |y_1 - y_2| = 2|x_1 - x_2| = 2\sqrt{6} |\lambda|$$

$$\therefore RS^2 = (x_1 - x_2)^2 + (y_1 - y_2)^2 \Rightarrow 270 = 30\lambda^2 \Rightarrow \lambda^2 = 9$$

$$\therefore \text{Slope of } RS = 2 \text{ and mid-point of } RS \text{ is } \left(\frac{x_1 + x_2}{2}, \frac{y_1 + y_2}{2} \right) \equiv (0, 1)$$

$$\text{So, } R'S' \equiv y - 1 = -\frac{1}{2}x$$

$$\text{Solving } y - 1 = -\frac{1}{2}x \text{ with 'C' we get } x^2 = \frac{12}{7}\lambda^2$$

$$\Rightarrow |x_1 - x_2| = 2\sqrt{\frac{12}{7}} |\lambda| \text{ and } |y_1 - y_2| = \frac{1}{2}|x_1 - x_2| = \sqrt{\frac{12}{7}} |\lambda|$$

$$\text{Hence, } D = (R'S')^2 = (x_1 - x_2)^2 + (y_1 - y_2)^2 = \frac{12}{7} \cdot 9 \times 5 \approx 77.14$$

SECTION - 3

- This section contains **SIX (06)** questions.
- Each question has **FOUR** options (A), (B), (C) and (D). **ONE OR MORE THAN ONE** of these four option(s) is(are) correct answer(s).
- For each question, choose the option(s) corresponding to (all) the correct answer(s).
- Answer to each question will be evaluated according to the following marking scheme:

<i>Full Marks</i>	: +4	If only (all) the correct option(s) is(are) chosen;
<i>Partial Marks</i>	: +3	If all the four options are correct but ONLY three options are chosen;
<i>Partial Marks</i>	: +2	If three or more options are correct but ONLY two options are chosen, both of which are correct;
<i>Partial Marks</i>	: +1	If two or more options are correct but ONLY one option is chosen and it is a correct option;
<i>Zero Marks</i>	: 0	If unanswere;
<i>Negative Marks</i>	: -2	In all other cases.
- For example, in a question, if (A), (B) and (D) are the ONLY three options corresponding to correct answers, then
 - choosing ONLY (A), (B) and (D) will get +4 marks;
 - choosing ONLY (A) and (B) will get +2 marks;
 - choosing ONLY (A) and (D) will get +2 marks;
 - choosing ONLY (B) and (D) will get +2 marks;
 - choosing ONLY (A) will get +1 mark;
 - choosing ONLY (B) will get +1 mark;
 - choosing ONLY (D) will get +1 mark;
 - choosing no option(s) (i.e., the question is unanswered) will get 0 marks and
 - choosing any other option(s) will get -2 marks.

11. For any 3×3 matrix M , let $|M|$ denote the determinant of M . Let

$$E = \begin{bmatrix} 1 & 2 & 3 \\ 2 & 3 & 4 \\ 8 & 13 & 18 \end{bmatrix}, P = \begin{bmatrix} 1 & 0 & 0 \\ 0 & 0 & 1 \\ 0 & 1 & 0 \end{bmatrix} \text{ and } F = \begin{bmatrix} 1 & 3 & 2 \\ 8 & 18 & 13 \\ 2 & 4 & 3 \end{bmatrix}$$

If Q is a nonsingular matrix of order 3×3 , then which of the following statements is(are) **TRUE**?

(A) $F = PEP$ and $P^2 = \begin{bmatrix} 1 & 0 & 0 \\ 0 & 1 & 0 \\ 0 & 0 & 1 \end{bmatrix}$

(B) $|EQ + PFQ^{-1}| = |EQ| + |PFQ^{-1}|$

(C) $|(EF)^3| > |EF|^2$

(D) Sum of the diagonal entries of $P^{-1}EP + F$ is equal to the sum of diagonal entries of $E + P^{-1}FP$

Answer (A, B, D)



Sol. $\therefore P$ is formed from I by exchanging second and third row or by exchanging second and third column.

So, PA is a matrix formed from A by changing second and third row.

Similarly AP is a matrix formed from A by changing second and third column.

Hence, $\text{Tr}(PAP) = \text{Tr}(A) \quad \dots(1)$

(A) Clearly, $P \cdot P = \begin{bmatrix} 1 & 0 & 0 \\ 0 & 1 & 0 \\ 0 & 0 & 1 \end{bmatrix} = I$

and $PE = \begin{bmatrix} 1 & 2 & 3 \\ 8 & 13 & 18 \\ 2 & 3 & 4 \end{bmatrix} \Rightarrow PEP = \begin{bmatrix} 1 & 3 & 2 \\ 8 & 18 & 13 \\ 2 & 4 & 3 \end{bmatrix} = F$

$\Rightarrow PEP = F \Rightarrow PFP = E \quad \dots(2)$

(B) $\therefore |E| = |F| = 0$

So, $|EQ + PFQ^{-1}| = |PFPQ + PFQ^{-1}| = |P| |F| |PQ + Q^{-1}| = 0$

Also, $|EQ| + |PFQ^{-1}| = 0$

(C) From (2); $PFP = E$ and $|P| = -1$

So, $|F| = |E|$

Also, $|E| = 0 = |F|$

So, $|EF|^3 = 0 = |EF|^2$

(D) $\therefore P^2 = I \Rightarrow P^{-1} = P$

So, $\text{Tr}(P^{-1}EP + F) = \text{Tr}(PEP + F) = \text{Tr}(2F)$

Also $\text{Tr}(E + P^{-1}FP) = \text{Tr}(E + PFP) = \text{Tr}(2E)$

Given that $\text{Tr}(E) = \text{Tr}(F)$

$\Rightarrow \text{Tr}(2E) = \text{Tr}(2F)$

12. Let $f : \mathbb{R} \rightarrow \mathbb{R}$ be defined by

$$f(x) = \frac{x^2 - 3x - 6}{x^2 + 2x + 4}$$

Then which of the following statements is (are) **TRUE**?

(A) f is decreasing in the interval $(-2, -1)$ (B) f is increasing in the interval $(1, 2)$

(C) f is onto (D) Range of f is $\left[-\frac{3}{2}, 2\right]$

Answer (A, B)

Sol. $f(x) = \frac{x^2 - 3x - 6}{x^2 + 2x + 4}$

$\Rightarrow f'(x) = \frac{5x(x+4)}{(x^2 + 2x + 4)^2}$

$\Rightarrow f(x)$ has local maxima at $x = -4$ and minima at $x = 0$

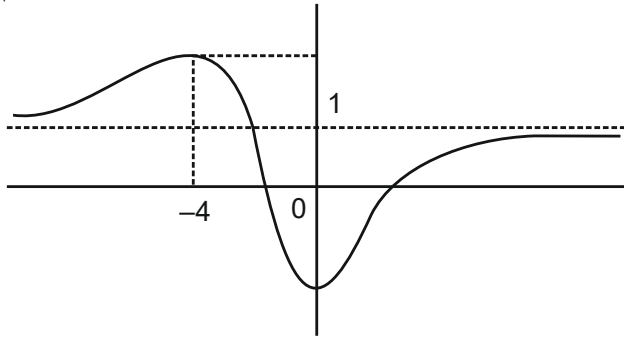

Range of $f(x)$ is $\left[-\frac{3}{2}, \frac{11}{6}\right]$

13. Let E, F and G be three events having probabilities

$$P(E) = \frac{1}{8}, P(F) = \frac{1}{6} \text{ and } P(G) = \frac{1}{4}, \text{ and } P(E \cap F \cap G) = \frac{1}{10}.$$

For any event H , if H^c denotes its complement, then which of the following statements is(are) **TRUE**?

- (A) $P(E \cap F \cap G^c) \leq \frac{1}{40}$ (B) $P(E^c \cap F \cap G) \leq \frac{1}{15}$
 (C) $P(E \cup F \cup G) \leq \frac{13}{24}$ (D) $P(E^c \cap F^c \cap G^c) \leq \frac{5}{12}$

Answer (A, B, C)

Sol. Let $P(E \cap F) = x, P(F \cap G) = y$ and $P(E \cap G) = z$

Clearly $x, y, z \geq \frac{1}{10}$

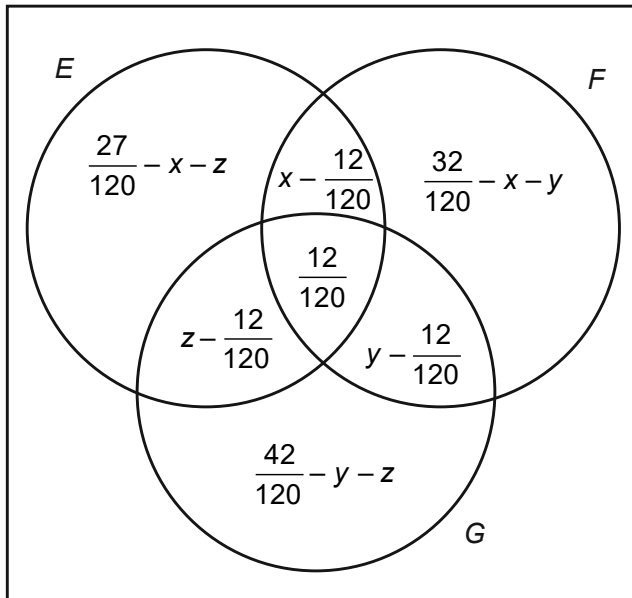

$$\because x + z \leq \frac{27}{120} \Rightarrow x, z \leq \frac{15}{120}$$

$$x + y \leq \frac{32}{120} \Rightarrow x, y \leq \frac{20}{120}$$

$$\text{and } y + z \leq \frac{42}{120} \Rightarrow y, z \leq \frac{30}{120}$$

$$\text{Now } P(E \cap F \cap G^c) = x - \frac{12}{120} \leq \frac{3}{120} = \frac{1}{40}$$

$$P(E^c \cap F \cap G) = y - \frac{12}{120} \leq \frac{80}{120} = \frac{1}{15}$$

$$P(E \cup F \cup G) \leq P(E) + P(F) + P(G) = \frac{13}{24}$$

$$\text{and } P(E^c \cap F^c \cap G^c) = 1 - P(E \cup F \cup G) \geq \frac{11}{24} \geq \frac{5}{12}$$

14. For any 3×3 matrix M , let $|M|$ denote the determinant of M . Let I be the 3×3 identity matrix. Let E and F be two 3×3 matrices such that $(I - EF)$ is invertible. If $G = (I - EF)^{-1}$, then which of the following statements is (are) **TRUE**?

- (A) $|FE| = |I - FE| |FGE|$ (B) $(I - FE)(I + FGE) = I$
 (C) $EFG = GEF$ (D) $(I - FE)(I - FGE) = I$

Answer (A, B, C)

Sol. $\therefore I - EF = G^{-1}$

$$\Rightarrow G - GEF = I \quad \dots(1)$$

$$\text{and } G - EFG = I \quad \dots(2)$$

Clearly $GEF = EFG$ (option C is correct)

$$\begin{aligned} \text{Also } (I - FE)(I + FGE) &= I - FE + FGE - FE + FGE \\ &= I - FE + FGE - F(G - I)E \\ &= I - FE + FGE - FGE + FE \\ &= I \text{ (option B is correct and D is incorrect)} \end{aligned}$$

$$\begin{aligned} \text{Now, } (I - FE)(I - FGE) &= I - FE - FGE + F(G - I)E \\ &= I - 2FE \end{aligned}$$

$$\Rightarrow (I - FE)(-FGE) = -FE$$

$$\Rightarrow |I - FE||FGE| = |FE|$$

15. For any positive integer n , let $S_n : (0, \infty) \rightarrow \mathbb{R}$ be defined by

$$S_n(x) = \sum_{k=1}^n \cot^{-1} \left(\frac{1 + k(k+1)x^2}{x} \right)$$

where for any $x \in \mathbb{R}$, $\cot^{-1}(x) \in (0, \pi)$ and $\tan^{-1}(x) \in \left(-\frac{\pi}{2}, \frac{\pi}{2}\right)$. Then which of the following statements is (are)

TRUE?

(A) $S_{10}(x) = \frac{\pi}{2} - \tan^{-1} \left(\frac{1 + 11x^2}{10x} \right)$, for all $x > 0$

(B) $\lim_{n \rightarrow \infty} \cot(S_n(x)) = x$, for all $x > 0$

(C) The equation $S_3(x) = \frac{\pi}{4}$ has a root in $(0, \infty)$

(D) $\tan(S_n(x)) \leq \frac{1}{2}$, for all $n \geq 1$ and $x > 0$

Answer (A, B)

$$\text{Sol. } S_n(x) = \sum_{k=1}^n \tan^{-1} \left(\frac{(k+1)x - kx}{1 + kx \cdot (k+1)x} \right)$$

$$= \sum_{k=1}^n \left(\tan^{-1}(k+1)x - \tan^{-1} kx \right)$$

$$= \tan^{-1}(n+1)x - \tan^{-1} x = \tan^{-1} \left(\frac{nx}{1 + (n+1)x^2} \right)$$

$$\text{Now (A) } S_{10}(x) = \tan^{-1} \left(\frac{10x}{1+11x^2} \right) = \frac{\pi}{2} - \tan^{-1} \left(\frac{1+11x^2}{10x} \right)$$

$$\text{(B) } \lim_{n \rightarrow \infty} \cot(S_n(x)) = \cot \left(\tan^{-1} \left(\frac{x}{x^2} \right) \right) = x$$

$$\text{(C) } S_3(x) = \frac{\pi}{4} \Rightarrow \frac{3x}{1+4x^2} = 1 \Rightarrow 4x^2 - 3x + 1 = 0 \text{ has no real root.}$$

$$\text{(D) For } x = 1, \tan(S_n(x)) = \frac{n}{n+2} \text{ which is greater than } \frac{1}{2} \text{ for } n \geq 3 \text{ so this option is incorrect.}$$

16. For any complex number $w = c + id$, let $\arg(w) \in (-\pi, \pi]$, where $i = \sqrt{-1}$. Let α and β be real numbers such

that for all complex numbers $z = x + iy$ satisfying $\arg\left(\frac{z + \alpha}{z + \beta}\right) = \frac{\pi}{4}$, the ordered pair (x, y) lies on the circle

$$x^2 + y^2 + 5x - 3y + 4 = 0$$

Then which of the following statements is (are) **TRUE**?

(A) $\alpha = -1$

(B) $\alpha\beta = 4$

(C) $\alpha\beta = -4$

(D) $\beta = 4$

Answer (B, D)

Sol. Circle $x^2 + y^2 + 5x - 3y + 4 = 0$ cuts the real axis (x-axis) at $(-4, 0)$, $(-1, 0)$

Clearly $\alpha = 1$ and $\beta = 4$

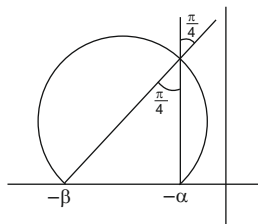

SECTION - 4

- This section contains **THREE (03)** questions.
- The answer to each question is a **NON-NEGATIVE INTEGER**.
- For each question, enter the correct integer corresponding to the answer using the mouse and the on-screen virtual numeric keypad in the place designated to enter the answer.
- Answer to each question will be evaluated according to the following marking scheme:

Full Marks : +4 If ONLY the correct integer is entered.

Zero Marks : 0 In all other cases.

17. For $x \in \mathbb{R}$, the number of real roots of the equation

$$3x^2 - 4|x^2 - 1| + x - 1 = 0$$

is _____.

Answer (4)

Sol. $3x^2 - 4|x^2 - 1| + x - 1 = 0$

Let $x \in [-1, 1]$

$$\Rightarrow 3x^2 - 4(-x^2 + 1) + x - 1 = 0$$

$$\Rightarrow 3x^2 + 4x^2 - 4 + x - 1 = 0$$

$$\Rightarrow 7x^2 + x - 5 = 0$$

$$\Rightarrow x = \frac{-1 \pm \sqrt{1+140}}{2}$$

Both values acceptable

Let $x \in (-\infty, -1) \cup (1, \infty)$

$$x^2 - 4(x^2 - 1) + x - 1 = 0$$

$$\Rightarrow x^2 - x - 3 = 0$$

$$\Rightarrow x = \frac{1 \pm \sqrt{1+12}}{2}$$

Again both are acceptable

Hence total number of solution = 4

18. In a triangle ABC , let $AB = \sqrt{23}$, and $BC = 3$ and $CA = 4$. Then the value of

$$\frac{\cot A + \cot C}{\cot B}$$

is _____.

Answer (2)



Sol. With standard notations

Given : $c = \sqrt{23}$, $a = 3$, $b = 4$

$$\begin{aligned} \text{Now } \frac{\cot A + \cot C}{\cot B} &= \frac{\frac{\cos A}{\sin A} + \frac{\cos C}{\sin C}}{\frac{\cos B}{\sin B}} \\ &= \frac{\frac{b^2 + c^2 - a^2}{2bc \sin A} + \frac{a^2 + b^2 - c^2}{2ab \sin C}}{\frac{c^2 + a^2 - b^2}{2ac \sin B}} \\ &= \frac{\frac{b^2 + c^2 - a^2}{4\Delta} + \frac{a^2 + b^2 - c^2}{4\Delta}}{\frac{c^2 + a^2 - b^2}{4\Delta}} = \frac{2b^2}{a^2 + c^2 - b^2} = 2 \end{aligned}$$

19. Let \vec{u} , \vec{v} and \vec{w} be vectors in three-dimensional space, where \vec{u} and \vec{v} are unit vectors which are not perpendicular to each other and

$$\vec{u} \cdot \vec{w} = 1, \quad \vec{v} \cdot \vec{w} = 1, \quad \vec{w} \cdot \vec{w} = 4$$

If the volume of the parallelepiped, whose adjacent sides are represented by the vectors \vec{u} , \vec{v} and \vec{w} , is $\sqrt{2}$, then the value of $|3\vec{u} + 5\vec{v}|$ is _____.

Answer (7)

Sol. Given $[\vec{u} \ \vec{v} \ \vec{w}] = \sqrt{2}$

$$\text{Also } [\vec{u} \ \vec{v} \ \vec{w}]^2 = \begin{vmatrix} \vec{u} \cdot \vec{u} & \vec{u} \cdot \vec{v} & \vec{u} \cdot \vec{w} \\ \vec{v} \cdot \vec{u} & \vec{v} \cdot \vec{v} & \vec{v} \cdot \vec{w} \\ \vec{w} \cdot \vec{u} & \vec{w} \cdot \vec{v} & \vec{w} \cdot \vec{w} \end{vmatrix} = 2$$

Let $\vec{u} \cdot \vec{v} = k$ and substitute rest values, we get

$$\begin{vmatrix} 1 & K & 1 \\ K & 1 & 1 \\ 1 & 1 & 4 \end{vmatrix} = 2$$

$$\Rightarrow 4K^2 - 2K = 0$$

$$\Rightarrow \vec{u} \cdot \vec{v} = 0 \quad \text{or} \quad \vec{u} \cdot \vec{v} = \frac{1}{2}$$

(rejected)

$$\therefore \vec{u} \cdot \vec{v} = \frac{1}{2}$$

$$|3\vec{u} + 5\vec{v}|^2 = 9 + 25 + 30 \times \frac{1}{2} = 49$$

$$\Rightarrow |3\vec{u} + 5\vec{v}| = 7$$